



**Specifications and
Instruction Manuals of
the Direct Output Vibration Pickup
VP-422
(4-20mA Acceleration Type)**

Issued by **IMV CORPORATION**
Document No. TVE-5-5678E
Revision Rev5.0

Index

Introduction	2
Safety Precautions.....	2
1. Overview.....	4
2. Features.....	4
3. Specifications	5
4. Outer Dimensions of the Pickup and Cable.....	6
4.1 Drip-proof Direct-connect Type.....	6
4.2 Water Resistant Type	6
4.3 Water-proof Connector Type	7
4.4 Connector Cable for Water-proof Connector Type.....	7
5. Outer Dimensions of the Mounting Adapter (Quick Fit)	8
6. Frequency Response	8
7. Installation	9
7.1 Installation of the Pickup	9
7.2 Installation of the Cable	9
7.3 Wiring	10
8. Handling Precautions.....	11
10. Warranty	11
The Direct Output Vibration Pickup Lineup	12

Introduction

Thank you for purchasing the Direct Output Vibration Pickup VP-422.

Read this manual carefully to ensure the best performance and longest product life of the device. In addition, pay attention to the cautions described below to use the product safely.

◆ Notes



- (1) The Direct Output Vibration Pickup (hereinafter referred to as "pickup") is a device that diagnoses various vibrations for industrial equipment such as electric motors and pumps, and consumer equipment. Do not use it for any other purpose.
- (2) When wiring the pickup, make sure that the power supply source is "off" before performing the work.
- (3) Ground the system separately from the power equipment, and make sure to use the terminal block or binding post.
- (4) Signal line from the pickup should not be bundled with the power line or the signal line that generates noise but should be installed in a separate system.

Safety Precautions

It describes the items that you should follow to prevent harm to customers and other people and damage to property, and to use this product safely. Please be sure to read this manual and attached documents before use, and fully understand the contents for use.

After reading this manual, be sure to place it in a location so that you can always refer to it.

Expressions of Safety Instructions

Indication	Meaning of Indication
 Warning	Indicates the contents that may cause a dangerous situation of death or serious injury if mishandled.
 Caution	Indicates the contents that may cause serious injury or property damage if mishandled.
Note	Describes cases where there is no risk of injury to the operator, but it is expected to cause damage or failure to this product or other equipment or devices.

* "Serious injuries" are those with residual aftereffects such as blindness, injury, burns, electric shock, fractures, poisoning, and those requiring hospitalization or long-term hospital visits for treatment.

* "Minor injuries" are those that do not require hospitalization or long-term hospital visits for treatment (other than the "serious injuries" above).

In addition to the danger level classification, this document also uses the following notation:

Memo: "Memo" describes supplementary explanations that could not be explained in the text and information that is useful to know.

◆ For Safe Use

 **Warning**

- (1) Do not use this product as a life-threatening alarm device.
- (2) When installing this product or peripheral devices in a high place, be sure to use a workbench such as a stepladder.
- (3) Do not use it in abnormal conditions such as smoke, strange odor, or abnormal noise. Also, do not disassemble or modify this product regardless of whether it is normal or abnormal. It may cause electric shock, fire, or malfunction.
- (4) When the pickup is installed near a moving part of the machine, make sure that it is stopped before installing the pickup. Do not perform any installation work while the machine is in operation.

 **Caution**

- (1) Be sure to wear a helmet when working at heights.
- (2) When installing this product or peripheral devices in a high place, fix them firmly. If this product or peripheral devices fall, an accident may occur.
- (3) When the pickup is energized, do not touch the terminal block carelessly.

Note

- (1) When connecting the pickup to the measuring instruments, check the method that matches the specifications of the device to be connected. Improper connection may cause the product or connected devices to malfunction or be damaged.
- (2) Use the pickup in the environment described in this manual. If you use it in an environment not described in this manual, unexpected problems may occur. In addition, if the main unit is damaged or peripheral devices are damaged due to the above reasons, the warranty will be void.
- (3) Do not attach the pickup to the interference point or operating point of the machine to be measured. The machine may damage.

Memo

- (1) The pickup is a precision device. Please handle it with care.
- (2) When performing automatic measurement operation using the pickup, it may not be possible to record measurement data as expected if the settings are not correct. Please check in the actual environment whether the measurement data can be obtained as expected, and after confirming that there are no problems, start operation in earnest.

1. Overview

By supplying a DC voltage (15 to 30V), this product outputs a DC current (4 to 20mA) proportional to the vibration level (acceleration) of the installation point.

◆ Typical Applications

- (1) For vibration monitoring in manufacturing plants and machine tools
- (2) For incorporating such as fans, motors, compressors.

2. Features

- (1) Output is 4 to 20mA DC which is proportional to the vibration level of acceleration.
- (2) The pickup outputs 4 to 20mA DC, allowing direct connection to instrumentation control equipment such as recorders, PLC, and DCS.

4. Outer Dimensions of the Pickup and Cable

4.1 Drip-proof Direct-connect Type

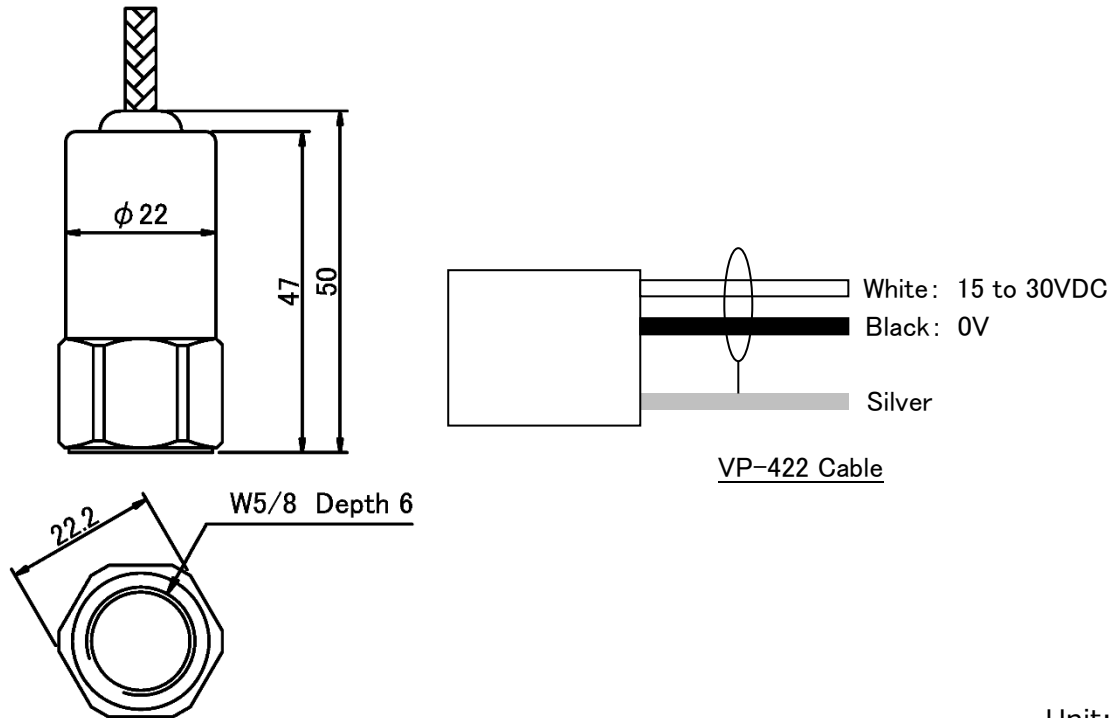

4.2 Water Resistant Type

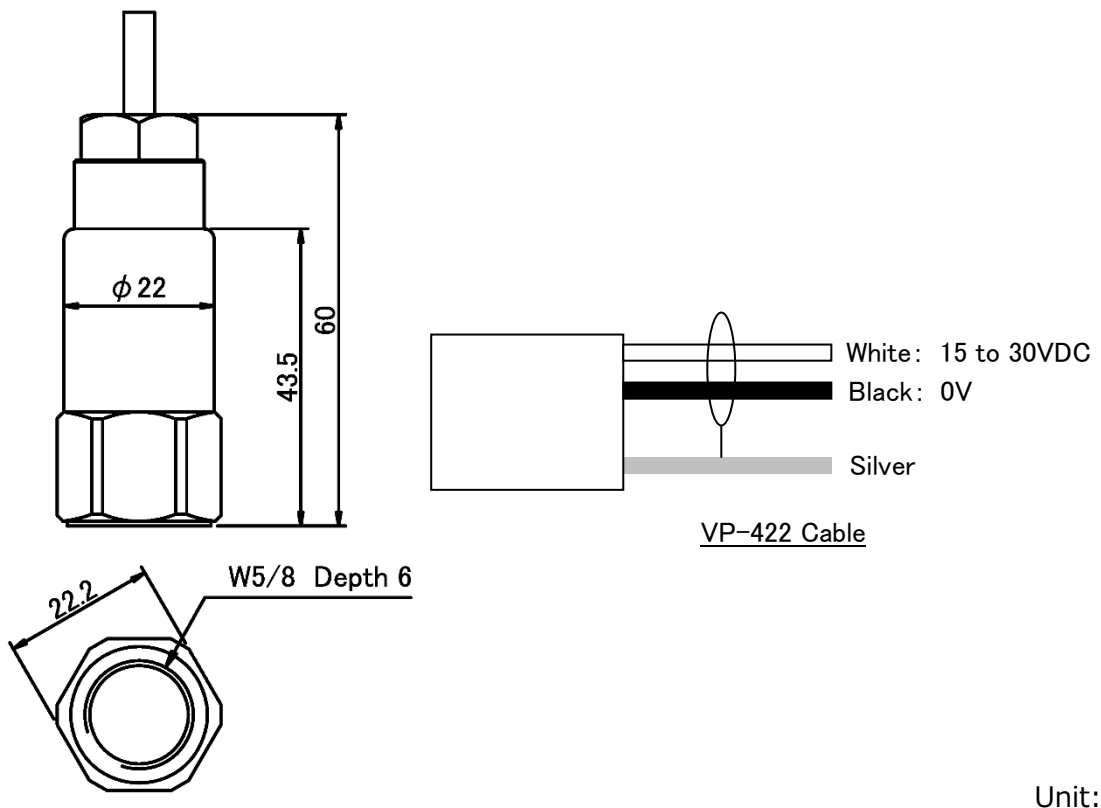

4.3 Water-proof Connector Type

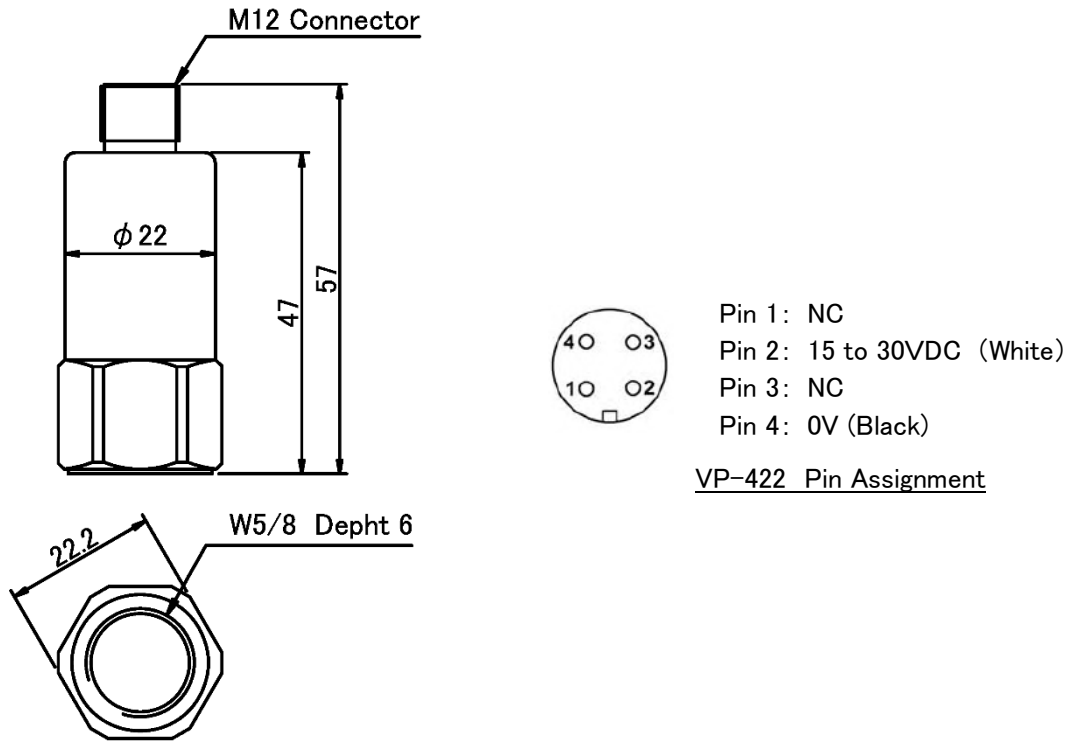

Unit: mm

4.4 Connector Cable for Water-proof Connector Type

Material of Cable Sheath	PUR
Diameter of Cable	$\phi 5.9$ (Nominal)
Outline View of Cable	See below figure

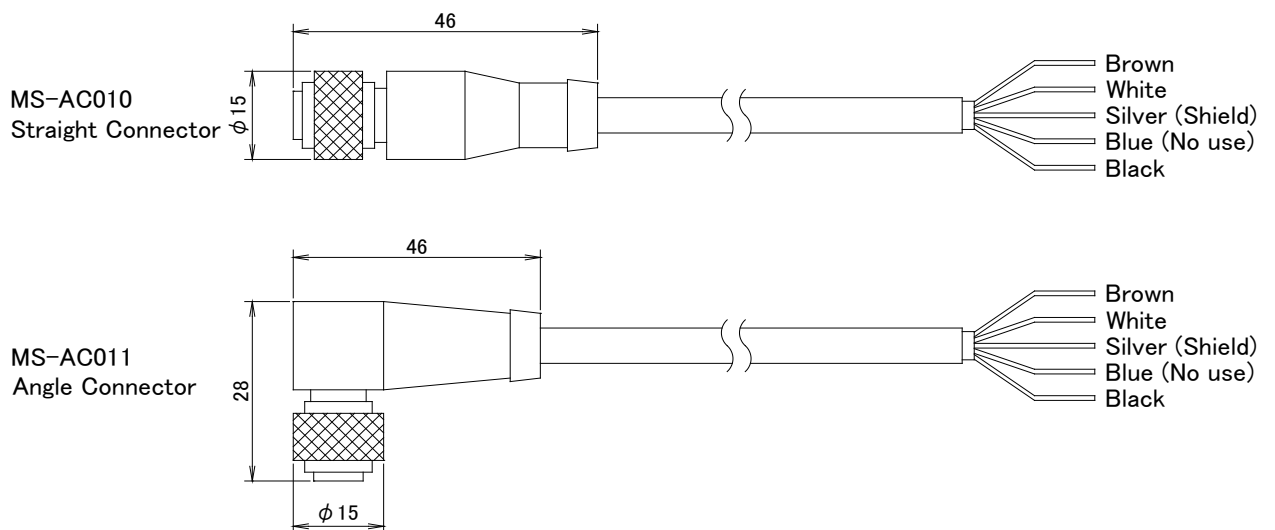

Unit: mm

5. Outer Dimensions of the Mounting Adapter (Quick Fit)

□ MS-AS001 (for Glue Face)

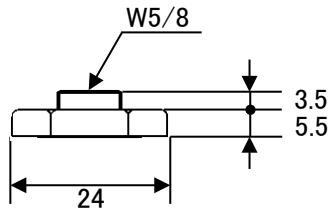

□ MS-AS002 (M8 Male)

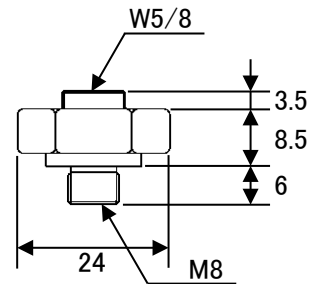

□ MS-AS003 (M6 Male)

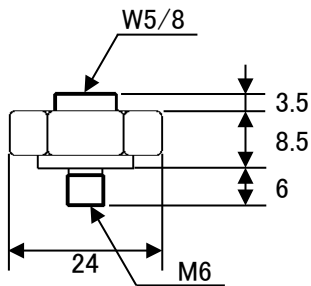

□ MS-AM005 (Magnet: $\phi 25.4$ mm Pole Piece)

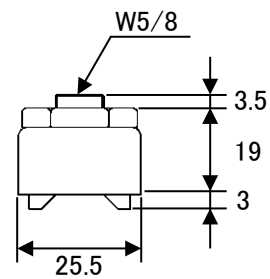

Unit: mm

6. Frequency Response

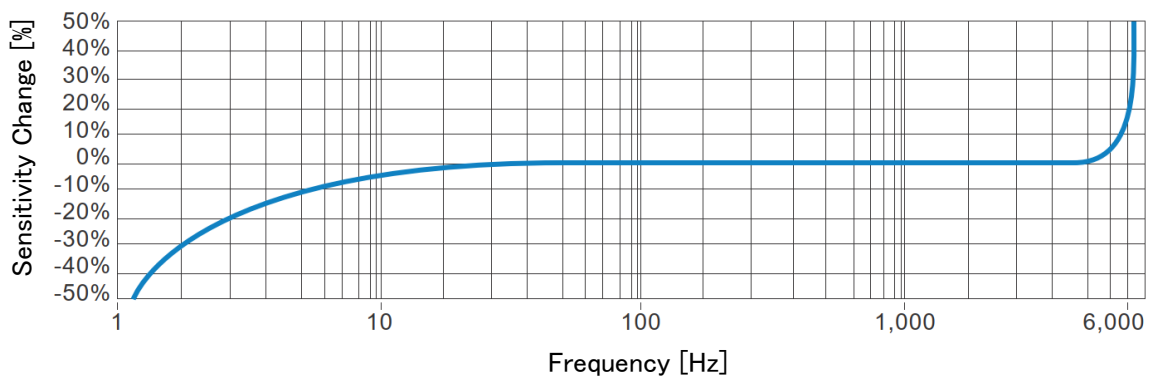

7. Installation

7.1 Installation of the Pickup

Mount the Quick Fit to the vibration measurement point and install the pickup above it (see Fig.7-1).

Ideally, the surface of the equipment on which the Quick Fit will be installed should be as flat as possible, and the contact surface should be coated with silicone grease or oil.

For a Water-Proof Connector Type pickup, fix pickup and then connect the dedicated cable.

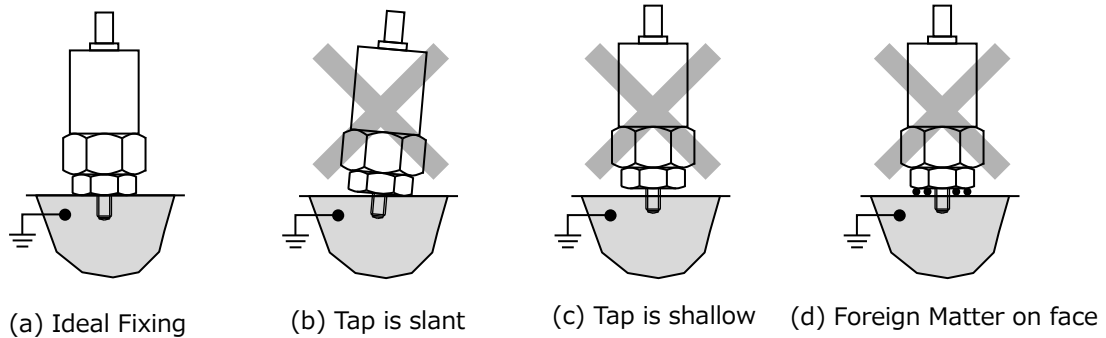

Fig.7-1 Installation of the Pickup (Examples of MS-AS002 or MS-AS003)

Note

Be sure to check the following items before installing the pickup.

- (1) Is the instrument to be measured grounded

If the pickup mounting surface (measurement target instrument) is not properly grounded, it may become charged and fail.

- (2) Is the pickup mounting surface cleanly finished

Remove completely dirt, dust, and paint at the mounting surface. Also, make sure that the tapped holes are upright with no foreign matter on the threads.

7.2 Installation of the Cable

- (1) The pickup cable fixes away from the equipment to be measured and at the location closest to it, and thereafter fixes the cable appropriately so that there is no slack.
- (2) When relaying the pickup cable, use the junction box, and use the twisted pair shielded cable that takes the installation environment into consideration. Also, keep the wiring as short as possible.

Memo

- (1) If the pickup cable is parallel to the power line such as the inverter, noise from the power line may affect the measurement. Install the pickup cable as far away from the power line as possible.
- (2) To protect the pickup cable from vibration, use a flexible conduit up to its near of installation point.
- (3) When relaying the pickup cable using the junction box, install it in an environment with as little noise as possible (in a place where noise countermeasures have been taken).

7.3 Wiring

Connect the pickup according to the example shown in Fig.7-2.

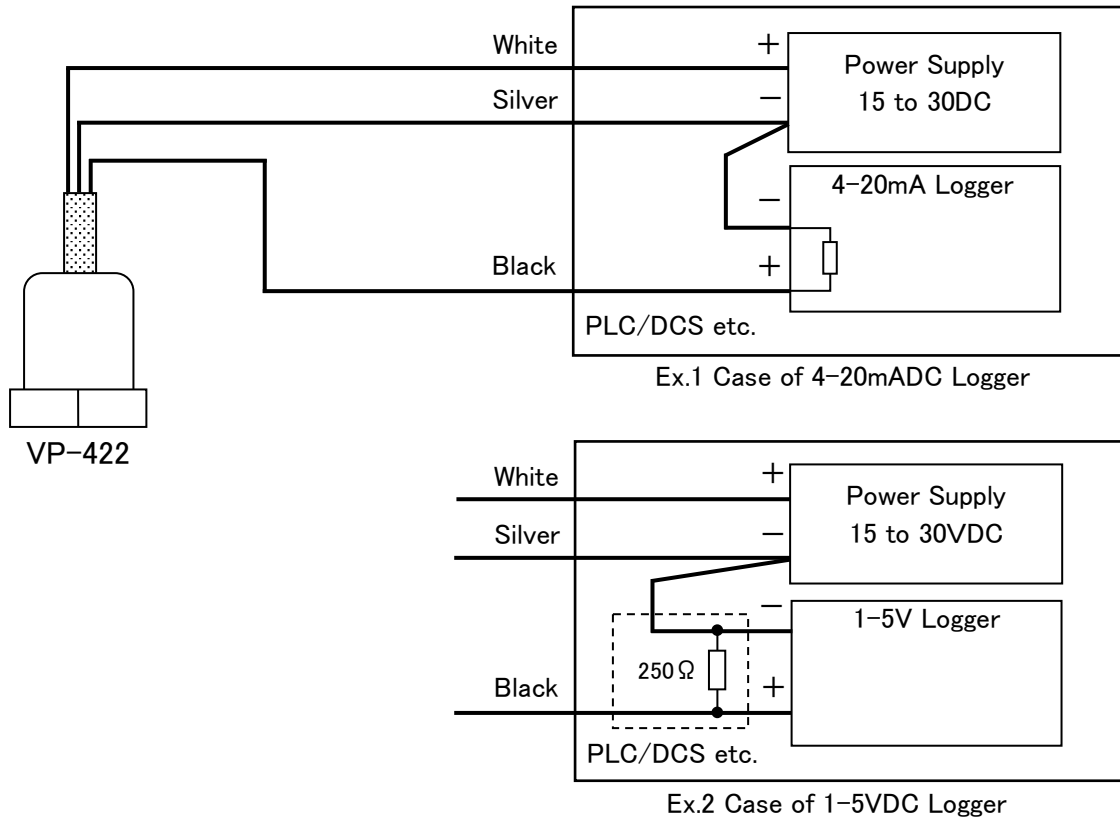

Fig.7-2 Example of Wiring

Note

- (1) Confirm “+” and “-” polarity first. If the polarity is opposite, the pickup cannot operate.
- (2) Do not supply power voltage more than the specification. It will cause a breakdown.
- (3) Shield wire (Silver) connect on minus side of the power supply.
- (4) In case of using any measuring instruments such as logger with 1 to 5VDC, connect 250Ω resistance with it in parallel.

Memo

Fig.7-2 is just an example of wiring. For details on connecting the pickup to the measuring instruments such as logger, PLC and DCS, refer to the instruction manuals of it.

Also, for information on how to connect the measuring instruments that support the connection of 2-wire transmitters, please refer to the instruction manuals of it.

We cannot provide individual answers regarding how to connect to the instrument.

8. Handling Precautions

Caution

- (1) Avoid moving the pickup during vibration measurement. When moving, turn off the power supply to the pickup before moving.
- (2) Use a 15 to 30VDC for the pickup and use a stable power supply with little external noise (noise surge pulse).

Note

When storing the pickup for a long period of time, avoid places exposed to direct sunlight, high humidity, and dusty places, and store it in a place within the operating temperature and humidity range.

Memo

When disposing of the pickup, dispose of it as industrial waste.

10. Warranty

If this product has a fault caused by the responsibility of IMV as the defect under production and material during warranty period, we will replace it free of charge.

The warranty period for the pickup is one year from the date of shipment. However, even within the warranty period, repairs will be charged in the following cases.

- (1) Any damage and breakdown caused by natural disasters such as fire, earthquake, flood, lightning damage.
- (2) Any transporting, moving, or dropping which does not relate to us after finishing our delivery.
- (3) Any error operation, unusual power supply input, and the fault caused by disassembling/repairing/modifying by customer.

The Direct Output Vibration Pickup Lineup

Model	Features	4 to 20mADC (*1)		ACC Waveform Output
		ACC RMS	VEL RMS	
VP-420	Outputs vibration level (Velocity) as a 4 to 20mA DC signal.		●	
VP-421	Outputs vibration level (Velocity) as a 4 to 20mA DC signal, and outputs acceleration waveform (AC) of the installation.		●	●
VP-422	Outputs vibration level (Acceleration) as a 4 to 20mA DC signal.	●		
VP-423	Outputs vibration level (Acceleration) as a 4 to 20mA DC signal, and outputs acceleration waveform (AC) of the installation.	●		●

*1 The meaning of each phrase is as follows:

ACC: Acceleration, **VEL**: Velocity, **RMS**: Root Mean Square

Revision History		
Apr. 2021	Rev4.0	New Issued. (VP-422 and VP-423 specification documents were merged.)
Nov. 2024	Rev6.0	Updated layout. Revised outer dimensions of the VP-422. Deleted description of the VP-423 specifications.
Contact Information for Inquiries		
IMV CORPORATION MES Business Division (Vibration Measuring Systems Sales Section) Address: 2-6-10 Takejima, Nishiyodogawa-ku, Osaka, 555-0011, Japan TEL: +81 50 1745 6779 FAX: +81 6 6471 3158		

*** Specifications and appearance described in this document are subject to change without notice.**